

Aotoro®

ER18A-CDD-

圆柱型
Cylindrical type

INSTRUCTION MANUAL 使用说明书

PHOTOELECTRIC SENSOR
光电开关



A2302-18

Model selectable 型号选择

Detecting type 传感方式	Appearance 外形	Detecting distance 探测距离	Model型号		Detecting type 传感方式	Appearance 外形	Detecting distance 探测距离	Model型号	
			NPN output	PNP output				NPN output	PNP output
Diffuse reflective 直接反射型		10CM Red LED(红色光)	ER18A-D10C4	ER18A-D10B4	Diffuse reflective 直接反射型		<input type="checkbox"/> 10CM	CDD-11N	CDD-11P
		50CM Infrared LED(红外光)	ER18A-D50C4	ER18A-D50B4			<input type="checkbox"/> 40CM	CDD-40N	CDD-40P
Through-beam 对射型		15m Infrared LED(红外光)	发射: ER18A-T15DL 接收: ER18A-T15C4	发射: ER18A-T15DL 接收: ER18A-T15B4			<input type="checkbox"/> 10CM	CDD-11CN	CDD-11CP
							<input type="checkbox"/> 40CM	CDD-40CN	CDD-40CP

Specification 规格

Detection 检测方式		Diffuse reflective type 直接反射						Through-beam type 对射		
Function 机能		Red LED type 红色光型		Infrared LED type 红外光型				Infrared LED type 红外光型		
Model 型号	NPN	ER18A-D10C4	ER18A-D50C4	CDD-11N	CDD-40N	CDD-11CN	CDD-40CN	ER18A-T15DL	ER18A-T15C4	
	PNP	ER18A-D10B4	ER18A-D50B4	CDD-11P	CDD-40P	CDD-11CP	CDD-40CP	ER18A-T15DL	ER18A-T15B4	
Detecting distance 探测距离		10cm (White paper白纸 10x10cm)	50cm (White paper白纸 20x20cm)	10cm (White paper白纸 10x10cm)	40cm (White paper白纸 20x20cm)	10cm (White paper白纸 10x10cm)	40cm (White paper白纸 20x20cm)	0-15m		
Detecting target 探测物体		Transparent, Translucent, Opaque material 透明体, 半透明体, 不透明体						Opaque materials of Min.φ15mm 直径15mm以上不透明体		
Operation mode 操作模式		Light ON or Dark ON selectable by wiring 通过接线选择入光ON或遮光ON								
Response time 响应时间		Max.1ms								
Power supply 电源电压		DC12-24V±10%以下								
Current consumption 静态电流		Max.15mA								
Control output 控制输出		Open collector output: Max.100mA 集电极开路输出								
Residual voltage 残留电压		Max.1V (Load current less than 10mA) 负载电流小于10mA时 Max.2V (Load current less than 10-100mA) 负载电流10mA-100mA时								
Circuit protection 电路保护		Short-circuit protection, Reverse polarity protection 短路保护, 电源反连接保护								
Insulation resistance 绝缘		Min.20MQ(500VDC)								
Dielectric strength 耐电压		1500VAC 50/60HZ for 1minute								
Ambient illumination 使用环境照度		Sunlight 太阳光: Max. 10000lx, Incandescent lamp 日光灯: Max.3000lx								
Operating temperature 使用环境温度		-20 to 60°C(non-freezing condition 不结冰)								
Ambient humidity 使用环境湿度		35 to 85%RH								
Protection 保护结构		IP 64		IP 67				IP 64		
Material 材质		Case: ABS, Lens: PC 壳体: ABS, 镜头: PC			Case: BRASS, Lens: PC 壳体: 黄铜, 镜面: PC				Case: ABS, Lens: PC 壳体: ABS, 镜头: PC	

Product Picture 产品图片



CDD-

ER18A-

Control output diagram 控制输出图

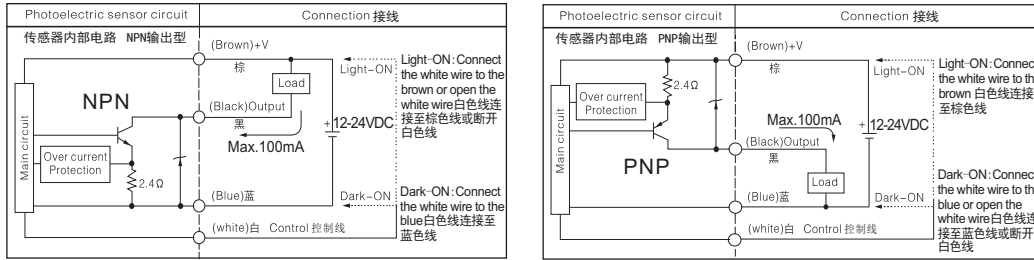

Light ON or Dark ON selectable by control wiring 通过接线(控制线)选择入光ON或遮光ON

Operation mode操作图解

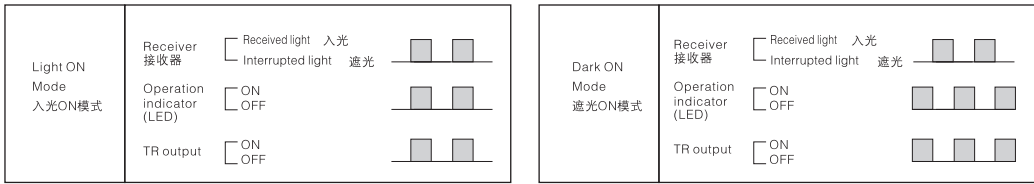

Connections 连接图

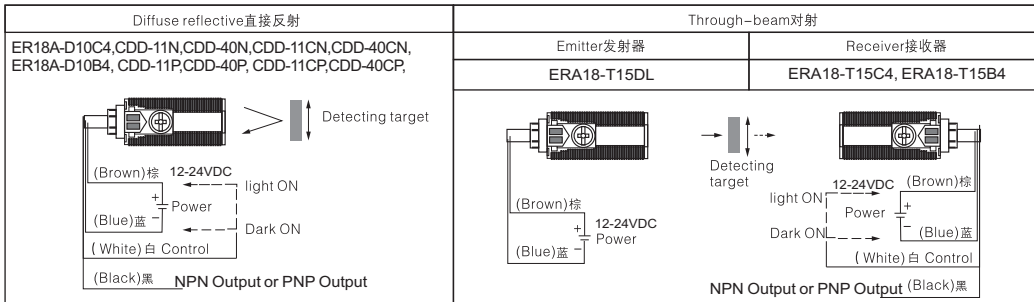

Dimensions 尺寸(unit:mm)

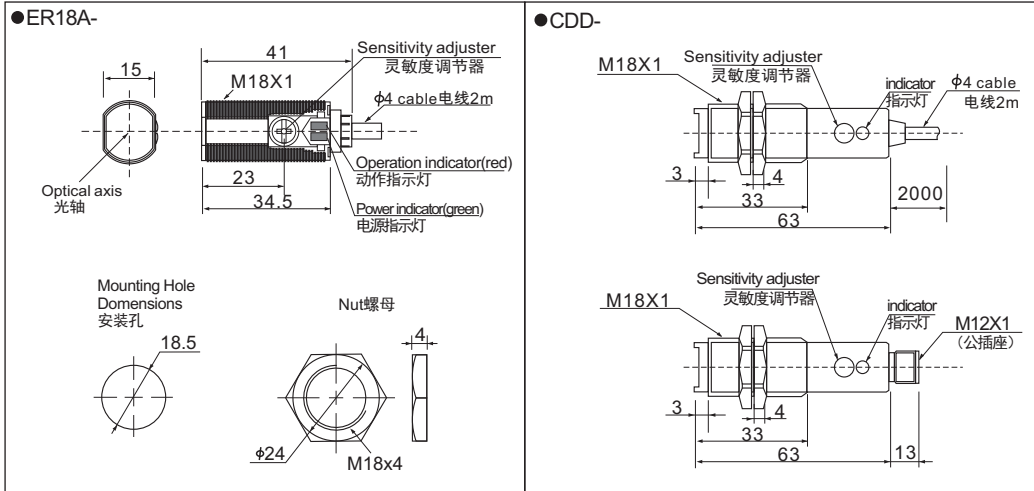

Installation and sensitivity adjustment 安装及感光度调节

Please supply the power to the sensor after installing the emitter and the receiver in face to face, and then adjust an optical axis and the sensitivity as follow; 面对面安装好发射器和接收器后请给传感器提供电源, 然后按以下说明调整光轴及感光度

● Diffuse reflective type 直接反射型

- Even though the diffuse reflective type is set at max. sensitive position. The sensitivity of the sensor must be adjusted in accordance with the existence of the reflective material in background. 即使是直接反射型也要进行最大感光度的设置。传感器感光度的调节必须和反射材料的背景保持一致

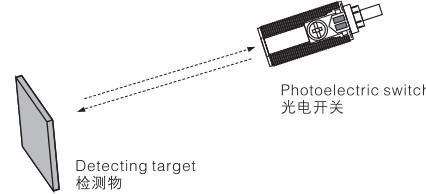

- Set the target at the area of the detecting, then turn the adjuster down to point ① where the indicator just turns on from Min. position of the adjuster. 安装检测物到可检测区域, 调节旋钮从最小位开始调节, 当调节到指示灯刚好亮时, 此时的旋钮位置为 ① 点
- Take the target out of the sensing area, then turn the adjuster until point ② where the indicator turns on. If the indicator does not turn on, max. Position is ② point. 从感应区域拿开检测物, 调节到指示灯亮时, 此时的旋钮位置为 ②, 如果指示灯一直不亮, 那么旋钮的最大位置就是 ② 的位置

两点中间位置就是最佳位
※ The detecting distance indicated in the specification chart is that of non-glossy white paper in the target size 100×100mm.
※ 检测物是规定的100×100mm的白色无光泽纸

Precautions in using the product 使用注意事项

NOTE 注意

Be sure to follow the safety precautions below for adder safety 以下项目在安全确保方面非常重要, 请务必遵守。

- Do not use the sensor under the explosive or flammable gas environment. 请不要在具有可燃性、爆炸性气体的环境下使用。
- Never disassemble, repair or tamper the product. 请勿拆卸、修理、改造本产品。
- Keep the supply voltage within the specified area. 电源电压必须在额定值内。
- use the load under the specified area. 请使用额定值以下的负荷。

Caution for using 正确使用方法

- Do not use the product under the following conditions. 请不要在以下的环境中使用。
 - In the place of the direct sunlight. 日光直射场所。
 - In the place where humidity is high and condensation may occur. 湿度高或易结露场所。
 - In the place of the corrosive gas exists. 含腐蚀性气体场所。
 - In the place where vibration or shock is directly transmitted to the product. 振动或冲击能直接传送到传感器场所。
- Connection and Mounting 连接和安装
 - Be sure that before giving the power, the supply voltage is less than the maximum rated supply voltage. 通电前请确认供电电源电压小于最大允许电源电压。
 - There are some cases where the photoelectric switch cable is unavoidably laid in a tube or duct together with a high tension or power line. This causes an induction, possibly resulting in malfunction or damage. In principal, the cable should be separately laid or shielded. 传感器导线和动力线或电力线装在同一配管中使用时, 会受到干扰, 有误动作甚至被损坏。原则上传感器导线必须单独放置或者被屏蔽。

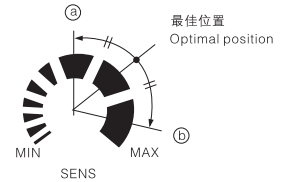

● Through-Beam type 对射型

- Supply the power to the photoelectric sensor, after installing the emitter and the receiver face to face. 面对面的安装好发射器及接收器后请给传感器提供电源
- Set the receiver in center of position where indicator turns on, when adjusting the receiver and the emitter right and left, up and down. 调整接收器和发射器的上下左右位置, 在指示灯亮时, 在中心位置安装好接收器
- Fix both units tightly after checking that the units detect the target. 检查检测目标后安装牢固传感器

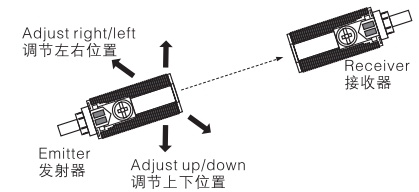

- For extending wires, whose cross section is greater than 0.3sqmm and the length less than 100m. 延长导线必须使用截面积0.3mm²以上、长度100m以下导线。
- Do not pull wire strongly. 导线请勿用力拉扯。
- Excessive force (hitting by hammer, etc.) should not be put on the sensors because it may damage its water-resistance. 安装传感器时, 请勿使传感器受剧烈外力(如用锤击打等), 这样就有可能破坏传感器防水保护性能。
- Power supply 电源
 - When using a commercially available switching regulator, be sure to ground the FG(Frame Ground) terminals. 使用市场上销售的开关整流器时, 请将FG(Frame Ground)端子接地。
 - Power supply reset time 电源重新调整时间
The photoelectric switch will begin sensing no later than 100ms after the power is turned on. If the load and the photoelectric switch connected to different power supply, the photoelectric switch must be always turned on first. 从接通电源到传感器可正常进行检出的时间是100ms后再使用。负载和传感器接不同电源时, 一定要先接通传感器的电源
 - Turning off the power supply 电源关闭
When turning off the power, output pulse may be generated. We recommend turning off the power supply of the load or load line first. 电源关闭时, 可能会出现输出脉冲, 所以我们建议先关闭负载或负载线的电源

浙江欧迪龙电子科技有限公司 Zhejiang Aotero Electronic Technology CO., LTD

ADD: Lihuang Road 2188#, Liushi town, Yueqing city, Zhejiang province . PRC 325604
浙江省乐清市柳市镇柳黄路2188号

TEL: 86-577-61758688 FAX: 86-577-62757002
Http://www.aotero.com E-mail: aotero@aotero.com